

# Organigramma Proposto

2022 - 2024

---

723 - ASST DEL GARDA

Sistema Socio Sanitario



Regione  
Lombardia

# Legenda



Dipartimento Gestionale



Dipartimento Funzionale

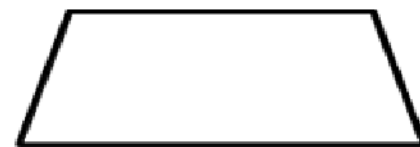

SC – Struttura Complessa

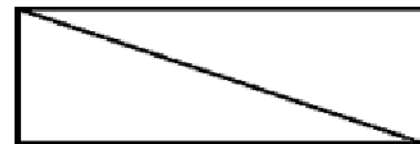

SSD – Struttura Semplice Dipartimentale

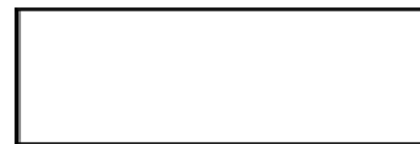

SS – Struttura Semplice

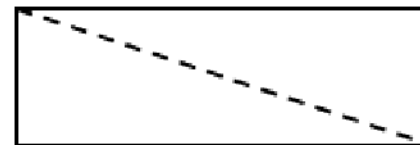

SD – Struttura Semplice Distrettuale



Funzione



Relazione Funzionale

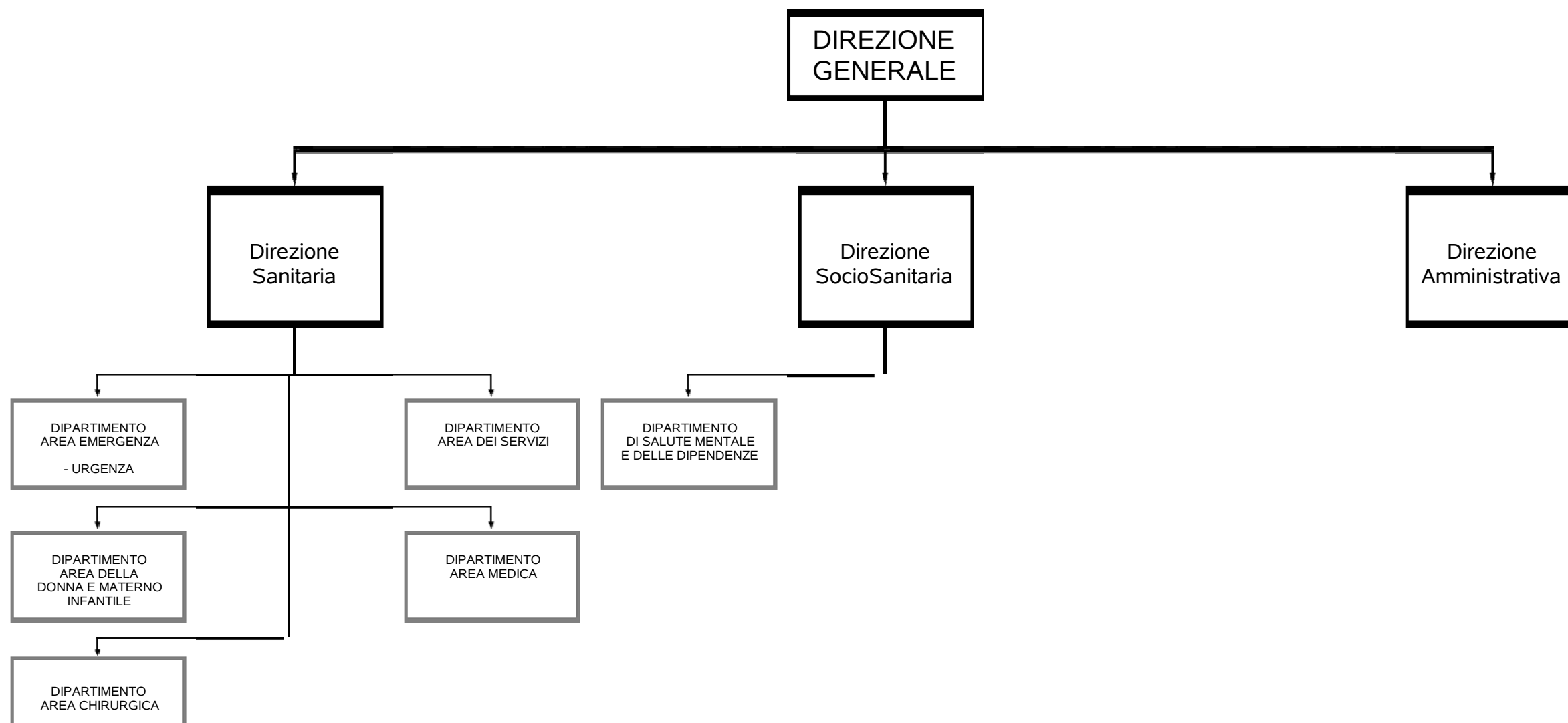

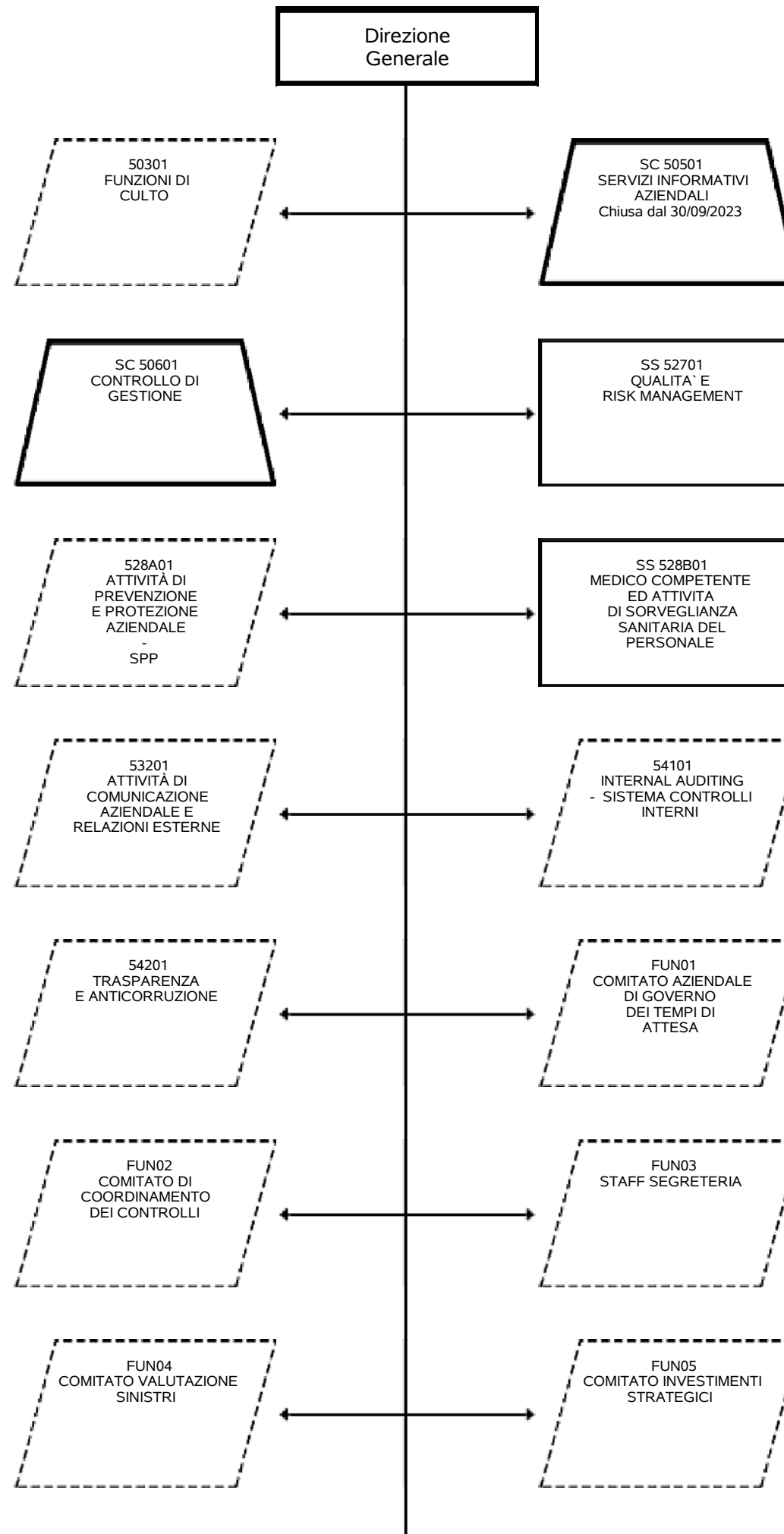

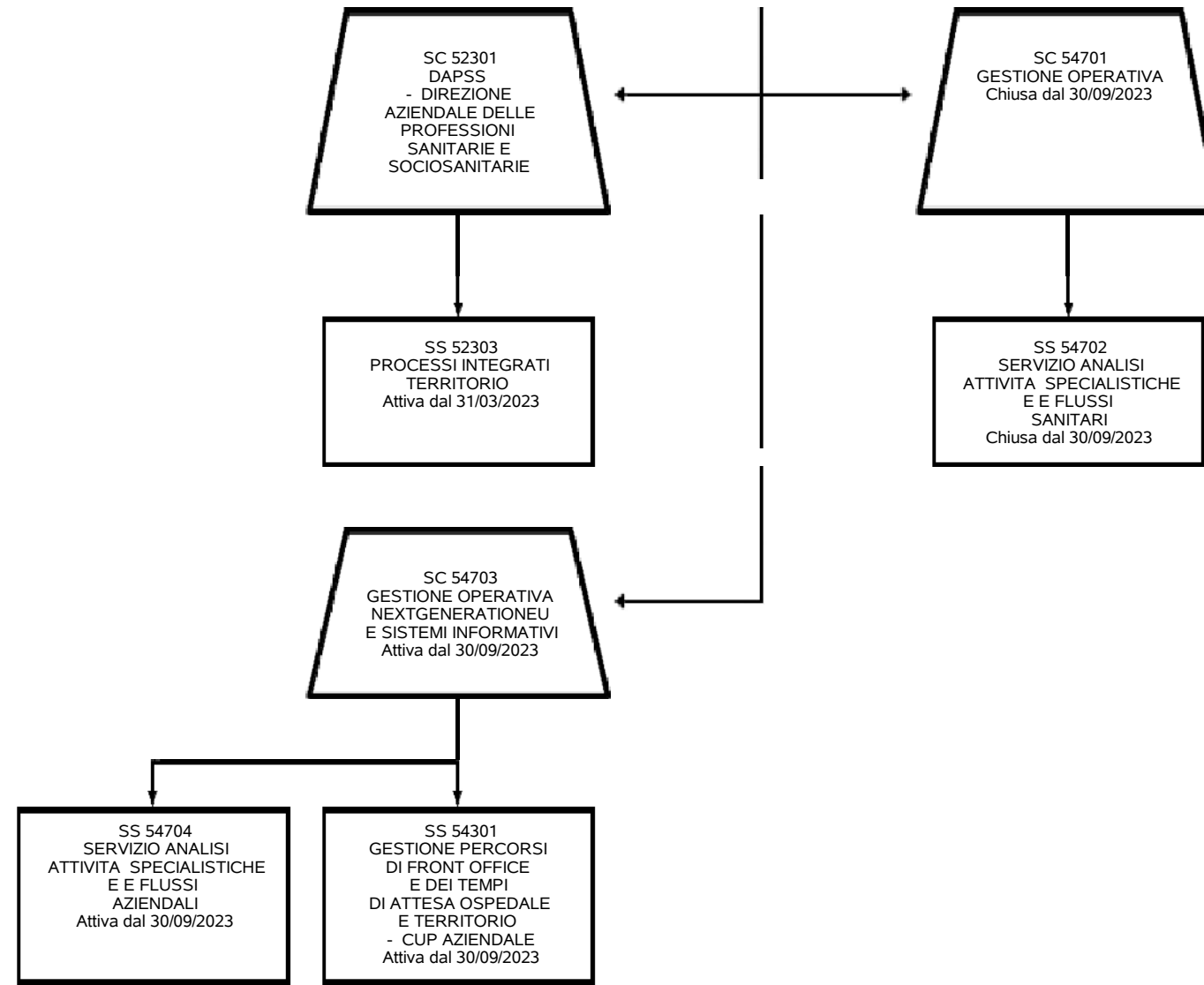

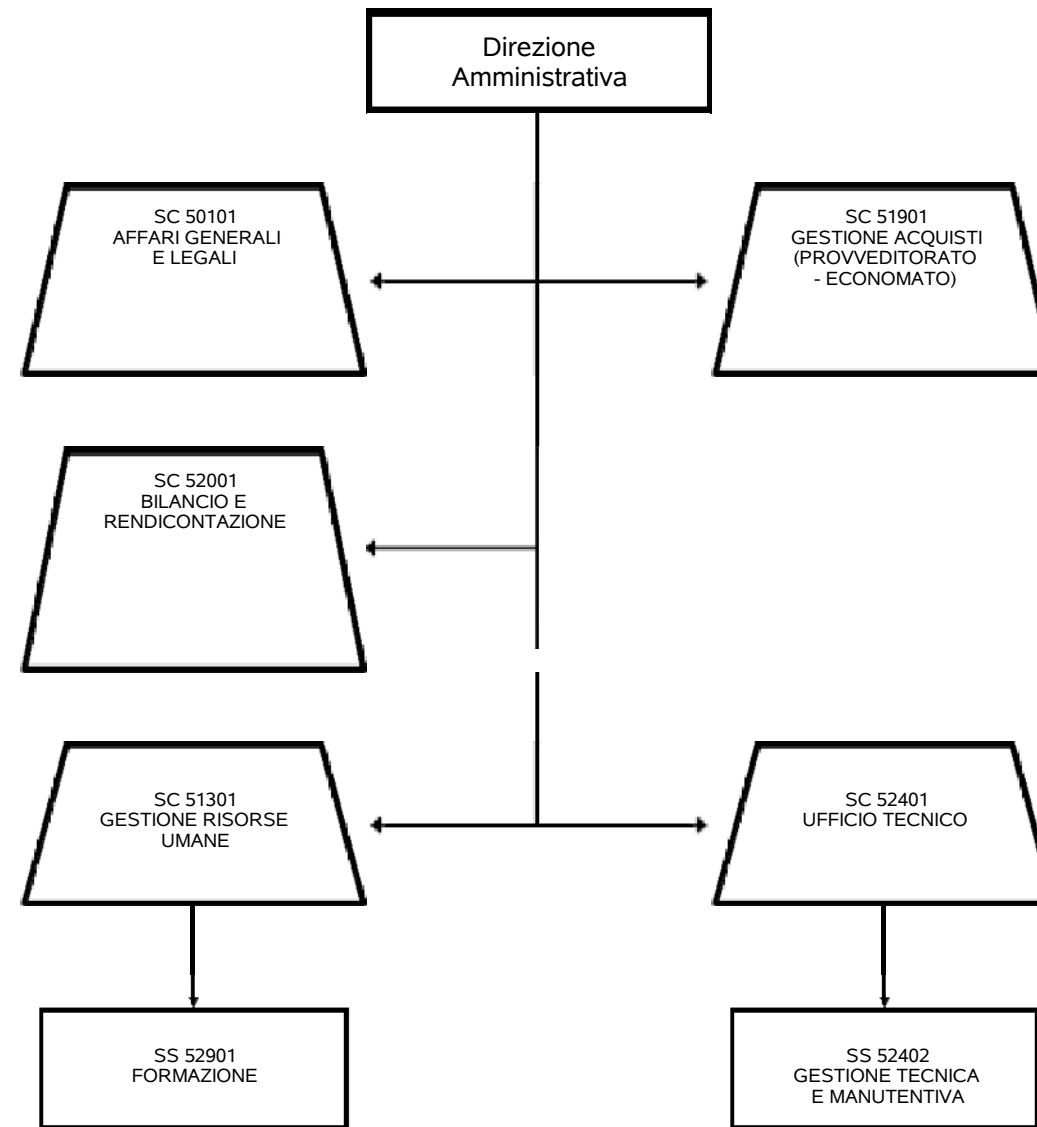

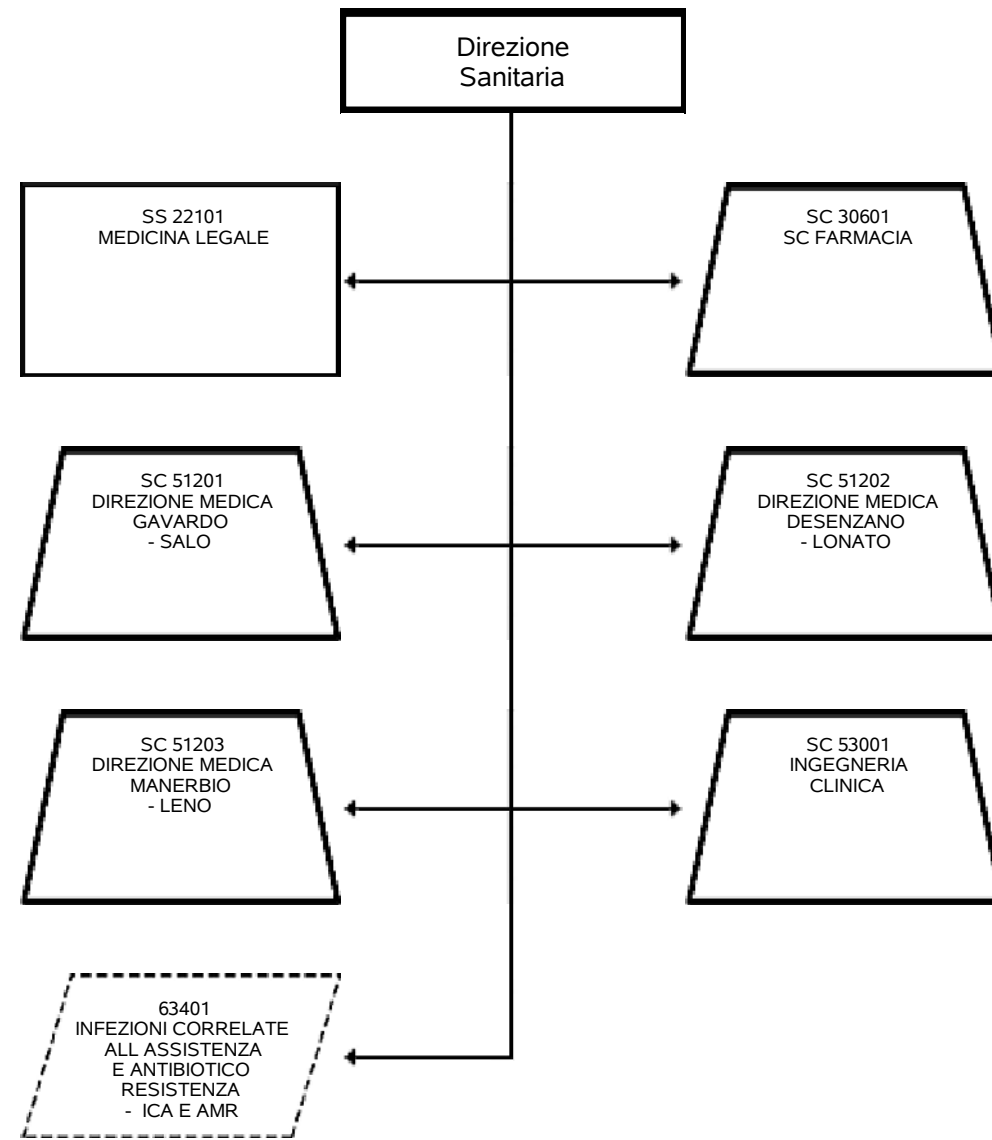

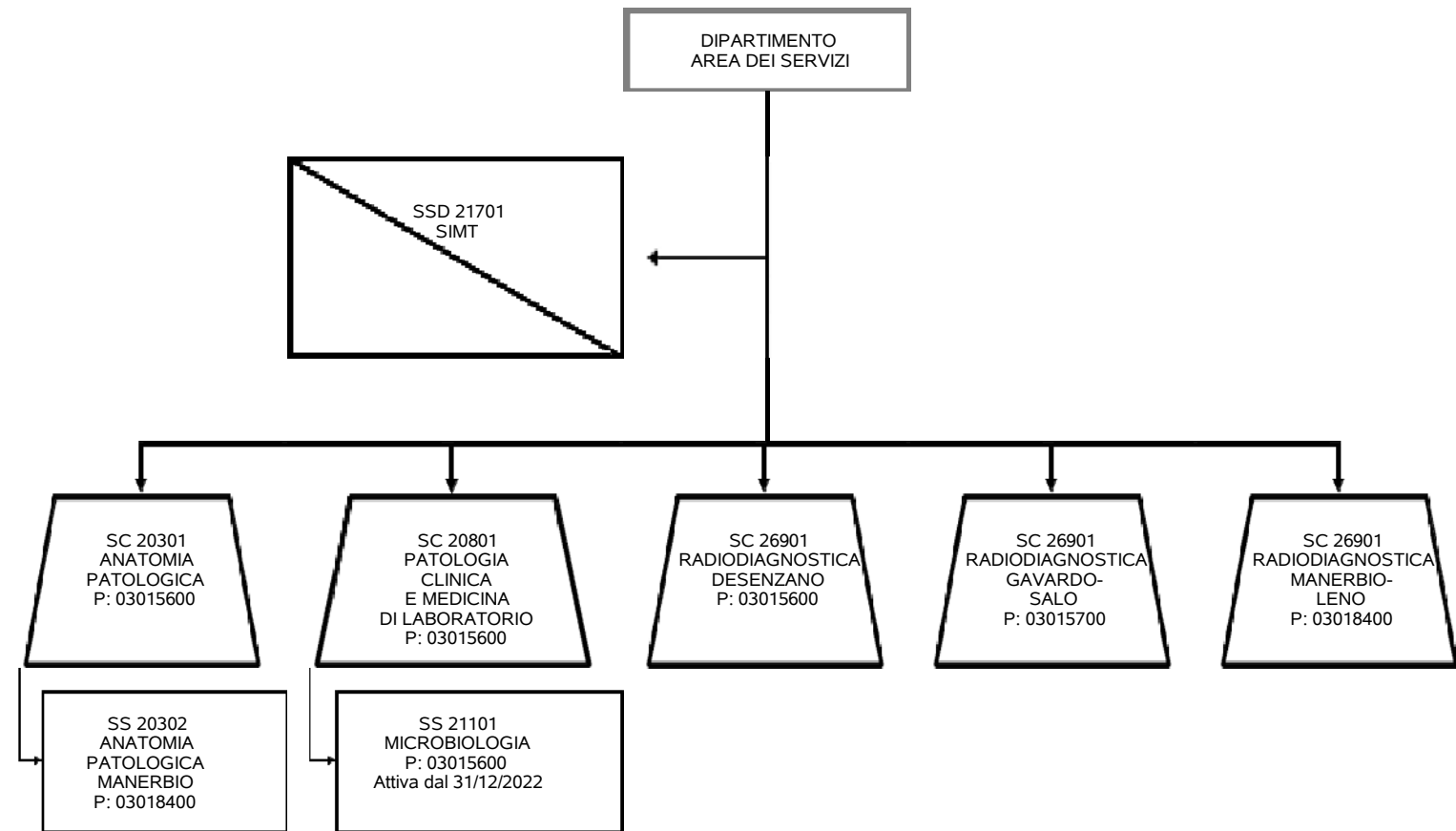



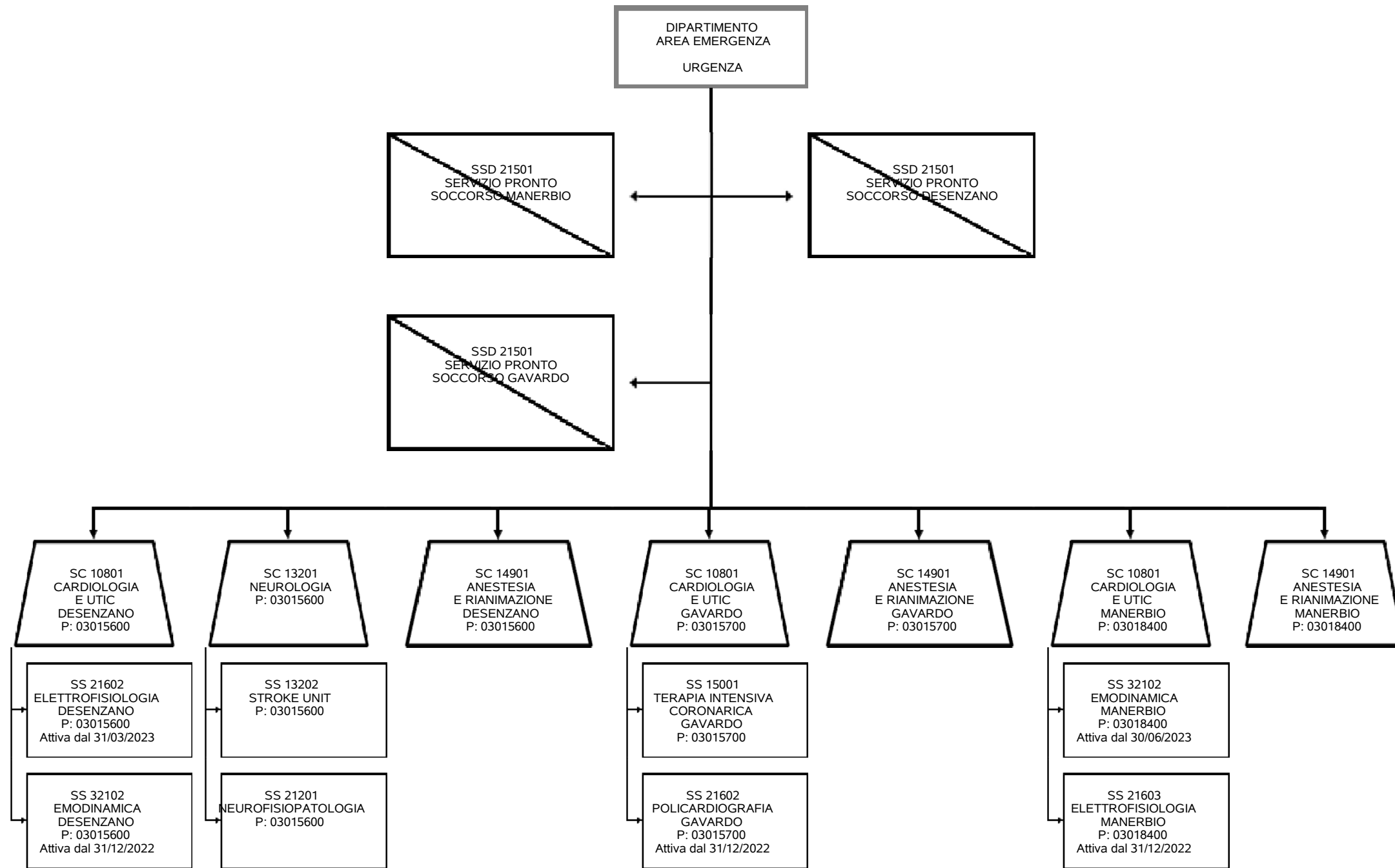

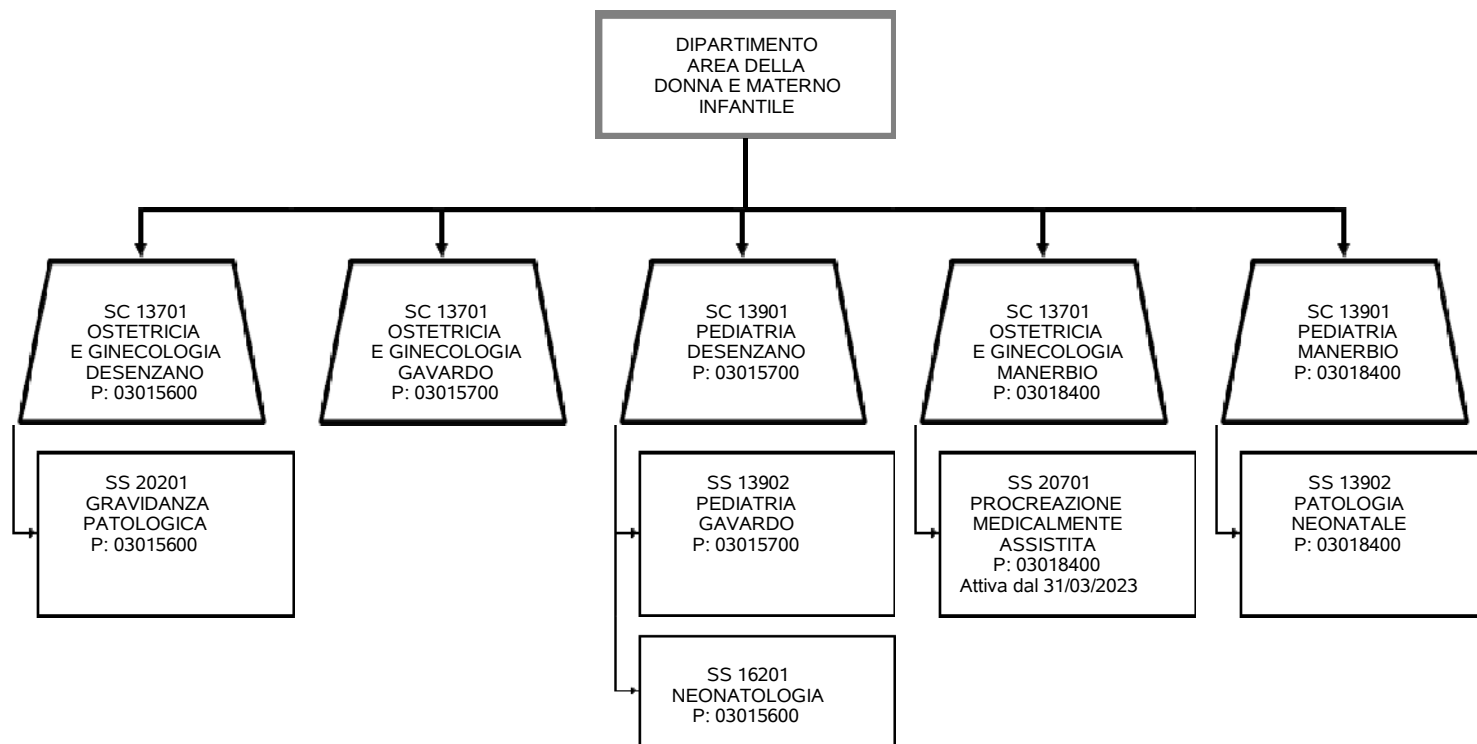

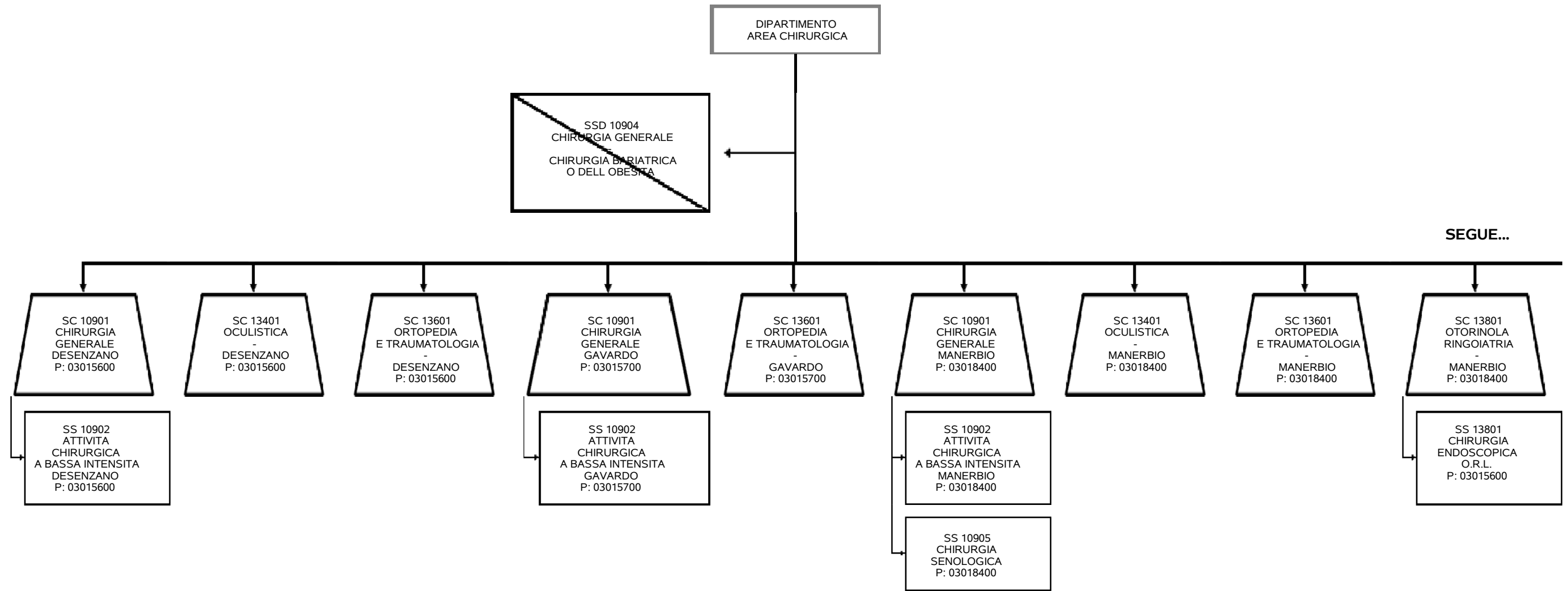

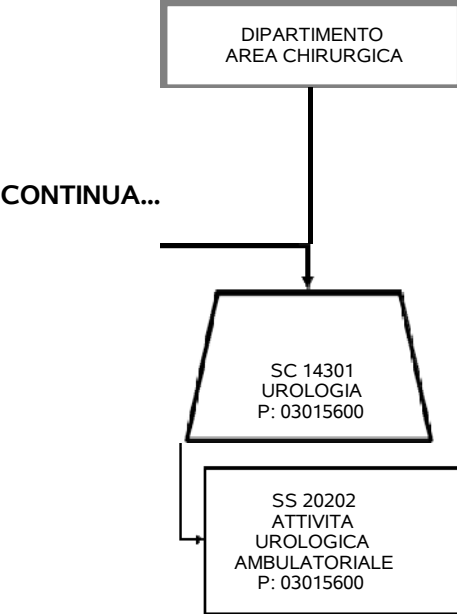

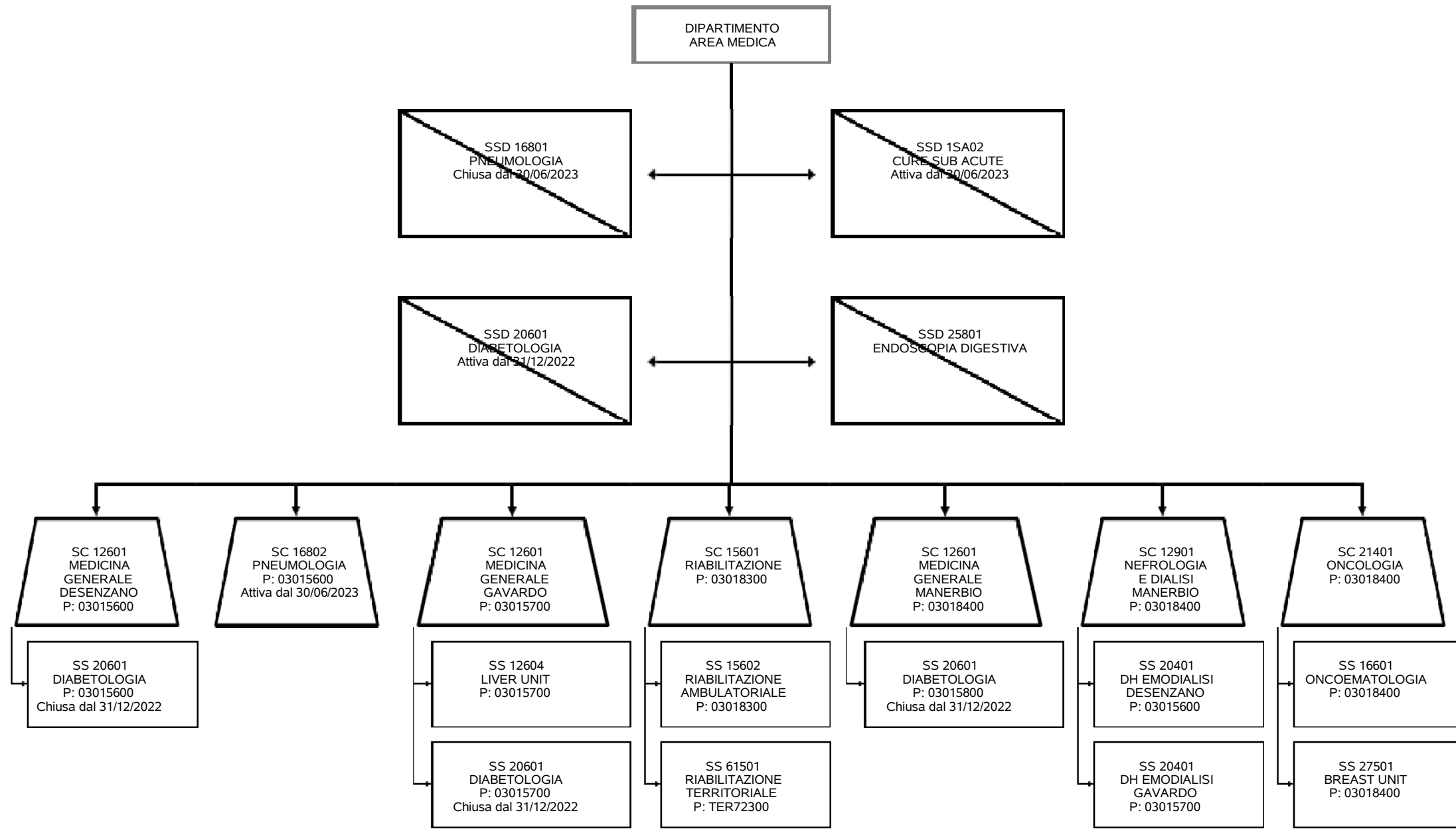

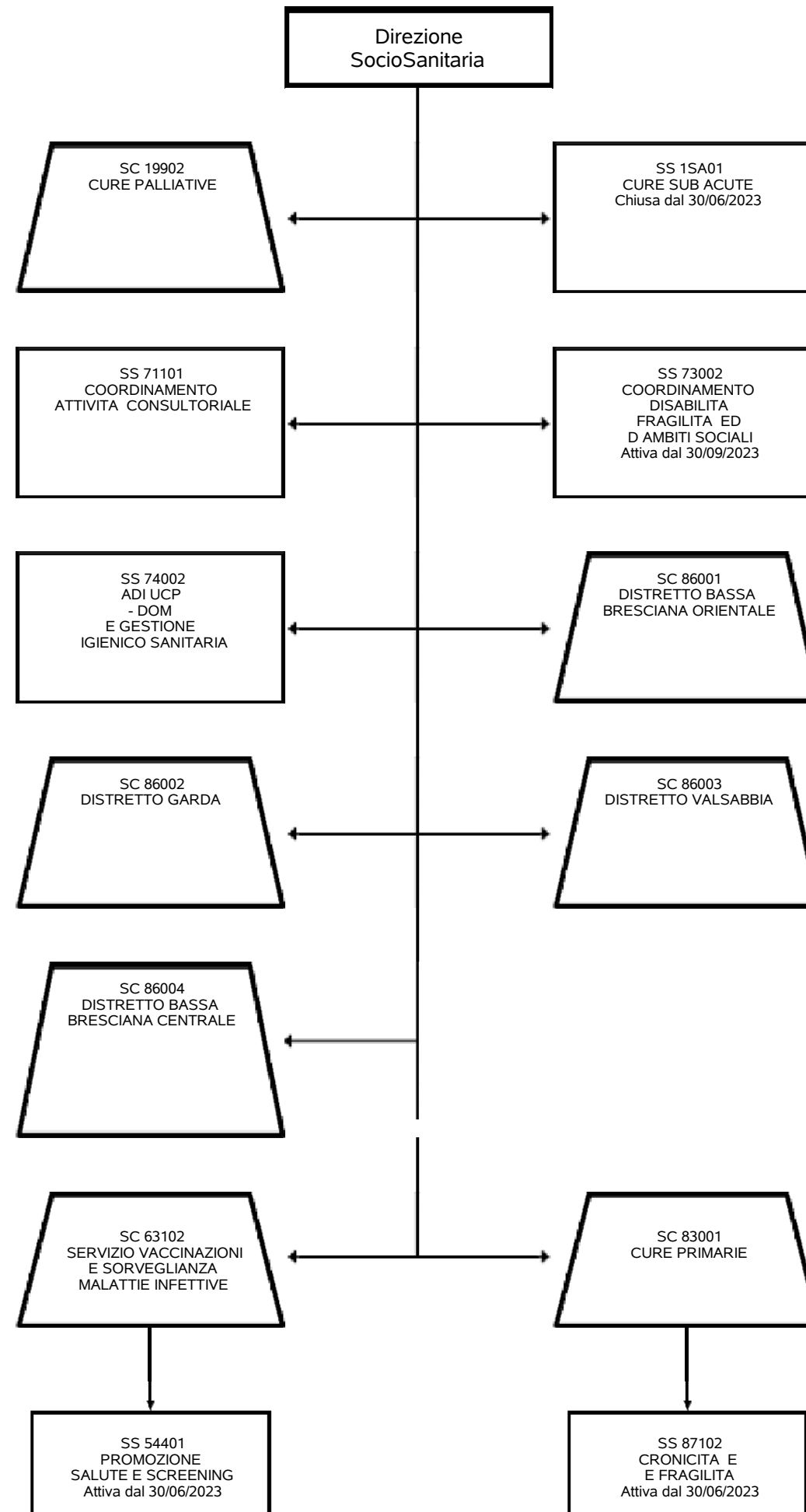



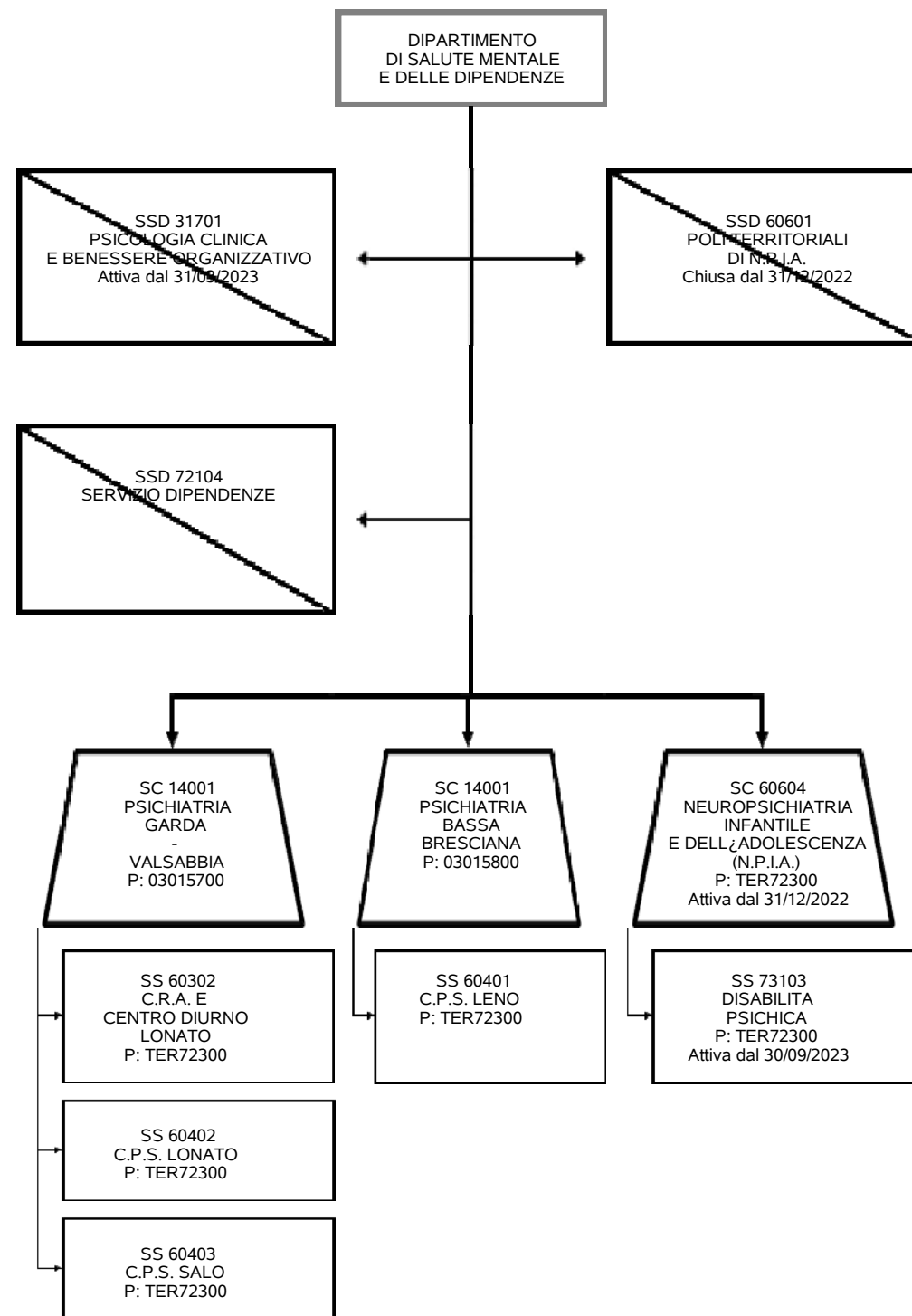



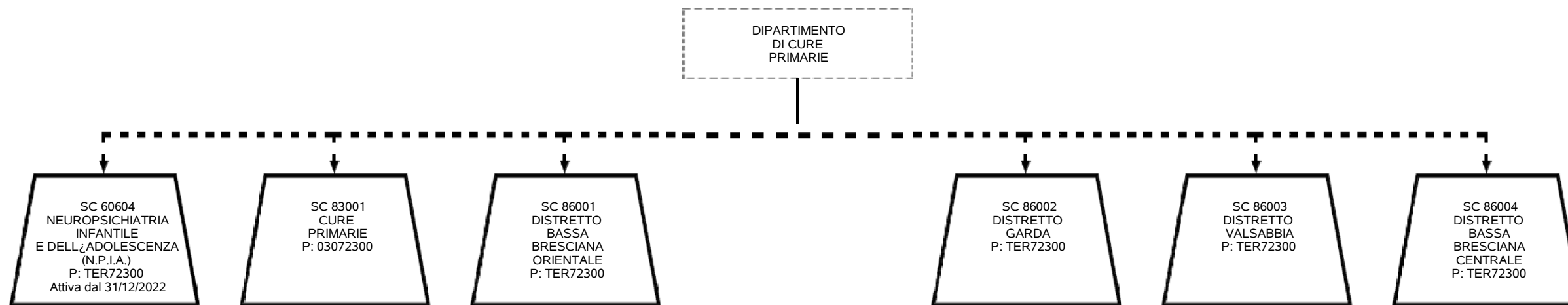

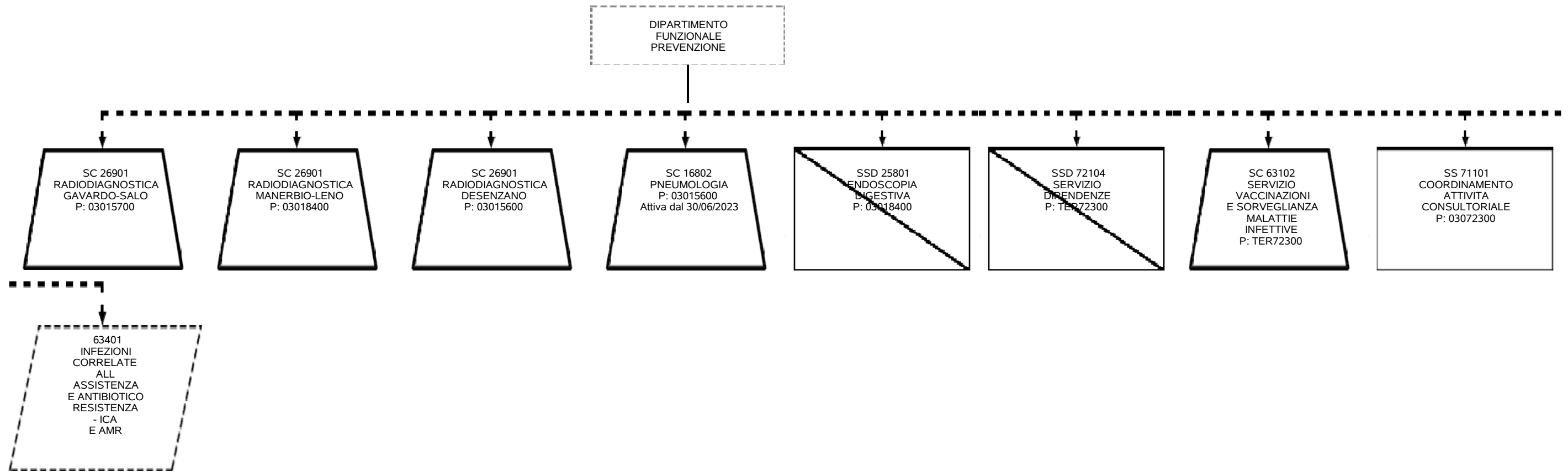

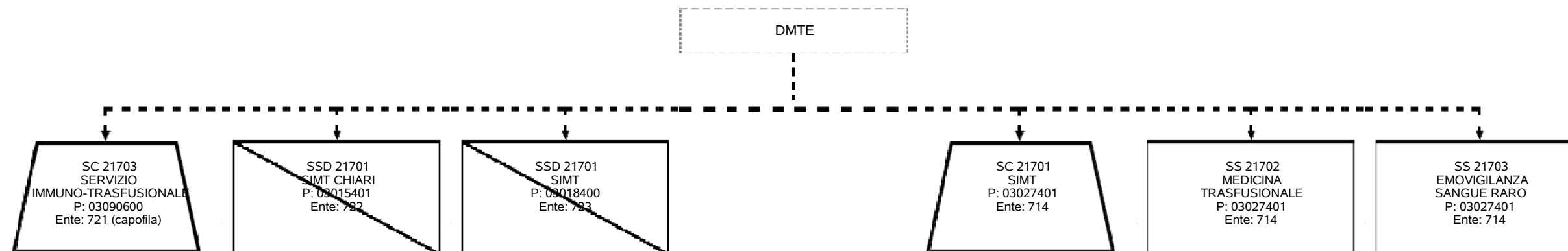

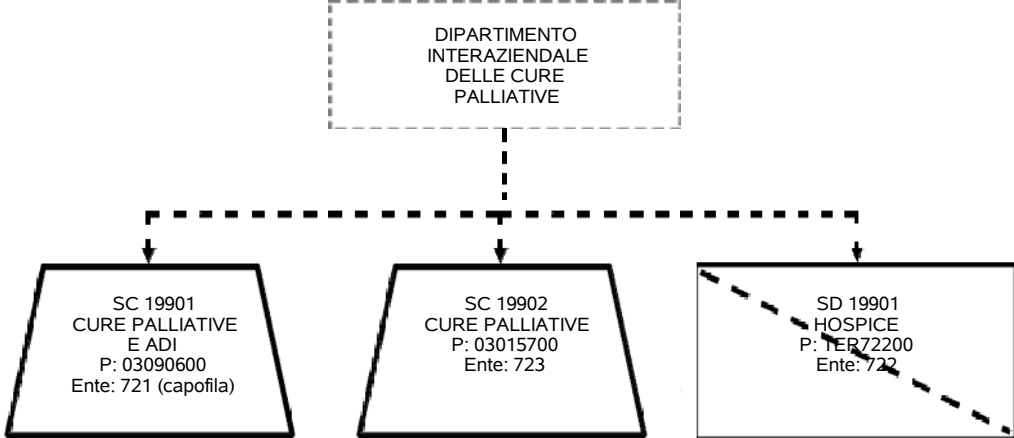

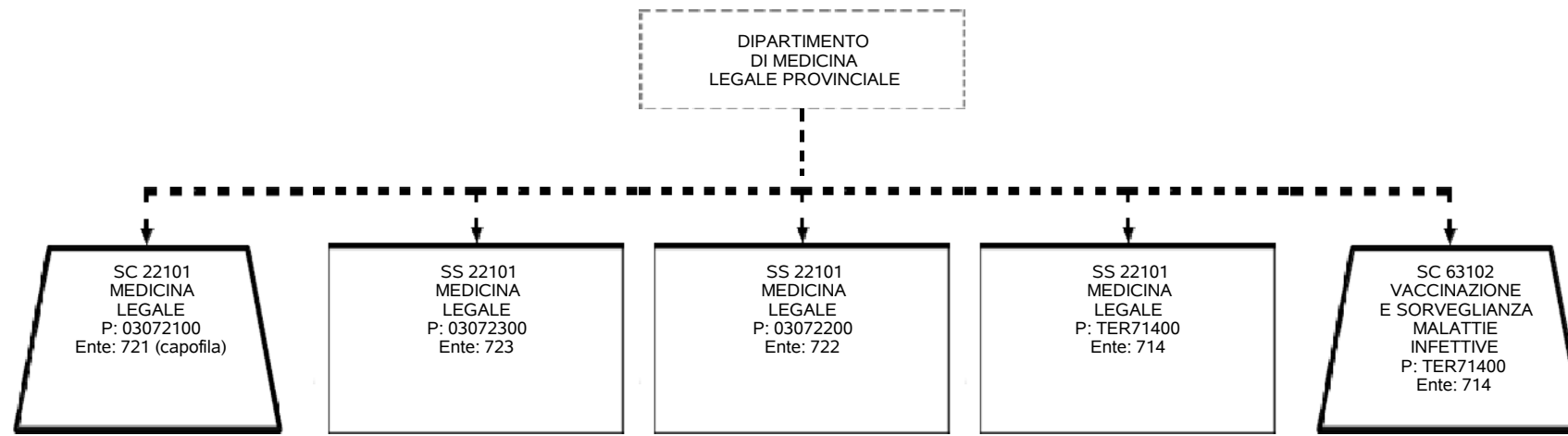

Codice Funzione	Descrizione Funzione	Codice Staff di Direzione	Descrizione Staff di Direzione	Presidio Afferenza SC	Codice Afferenza SC	Descrizione Afferenza SC
50301	FUNZIONI DI CULTO	SDG01	STAFF DELLA DIREZIONE GENERALE			
528A01	ATTIVITÀ DI PREVENZIONE E PROTEZIONE AZIENDALE- SPP	SDG01	STAFF DELLA DIREZIONE GENERALE			
53201	ATTIVITÀ DI COMUNICAZIONE AZIENDALE E RELAZIONI ESTERNE	SDG01	STAFF DELLA DIREZIONE GENERALE			
54101	INTERNAL AUDITING - SISTEMA CONTROLLI INTERNI	SDG01	STAFF DELLA DIREZIONE GENERALE			
54201	TRASPARENZA E ANTICORRUZIONE	SDG01	STAFF DELLA DIREZIONE GENERALE			
63401	INFEZIONI CORRELATE ALL'ASSISTENZA E ANTIBIOTICO RESISTENZA - ICA E AMR	SDS01	STAFF DELLA DIREZIONE SANITARIA			
FUN01	COMITATO AZIENDALE DI GOVERNO DEI TEMPI DI ATTESA	SDG01	STAFF DELLA DIREZIONE GENERALE			
FUN02	COMITATO DI COORDINAMENTO DEI CONTROLLI	SDG01	STAFF DELLA DIREZIONE GENERALE			
FUN03	STAFF SEGRETERIA	SDG01	STAFF DELLA DIREZIONE GENERALE			
FUN04	COMITATO VALUTAZIONE SINISTRI	SDG01	STAFF DELLA DIREZIONE GENERALE			
FUN05	COMITATO INVESTIMENTI STRATEGICI	SDG01	STAFF DELLA DIREZIONE GENERALE			